

SERIA WT

NOŻYCE DO ŚCINANIA DRZEW TREE SHEAR

WYCINKA DRZEW I KRZEWÓW
WSKAZANE DO PRACY W MIEJSCACH
Z TRUDNYM DOSTĘPEM

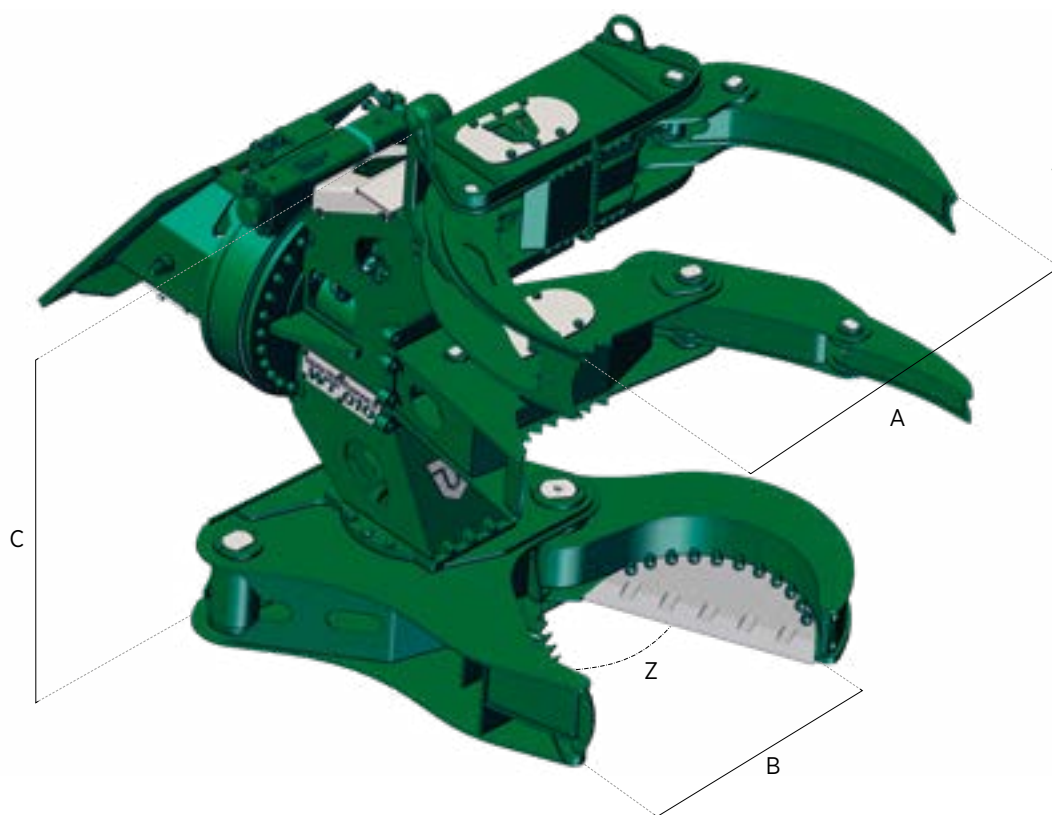

model			
WT 002	4,5	5	7
WT 004	5,5	6	9
WT 005	8	9	14
WT 010	12	13	18
WT 015	16	17	24
WT 020	21	23	35

ton

(1) Optymalna kombinacja koparka - osprzęt
Optimum excavator-equipment combination

















(2) Możliwa kombinacja koparka - osprzęt
Possible excavator-equipment combination



HARDOX
WEAR PLATE

HARDOX
IN MY BODY



		WT 002*	WT 004	WT 005		WT 010		WT 015		WT 020	
											
 kg.	kg.	340	430	545	60	1080	120	1730	120	1835	225
A	mm.	895	895	850		1150		1260		1500	
B	mm.	900	900	450		640		780		850	
C	mm.	590	615	1200		1530		1840		1850	
Z	t.	11	11	16		37		45		51	
 Ø max	mm.	150	150	250		350		450		500	
 max	bar	220	220	250		300		300		300	
	l/min.	50 / 60	50 / 60	60 / 80		80 / 100		130 / 150		150 / 180	
 max	bar	/	175	175		175		175		175	
 max	l/min.	/	20	20		40		40		40	

(* Model bez układu obrotowego 360° (** Model without rotation)