

**WE ARE DEMOLITION**



## **Creators Never Follow**

*Per essere come gli altri devi seguire le regole.  
Per essere unico devi creare le tue.*

*To be like others, you must follow the rules.  
To be unique, you must create your own.*



We are demolition\_video

# **MULTIPROCESSORY AUTOMATYCZNE**

UNIWERSALNE ROZWIĄZANIA

SERIA MK

**Dozer Mariusz Gołębiowski**  
ul. Jabłoniowa 33  
75-679 Koszalin  
POLSKA

T +48 882 070 497  
F +94 340 45 79  
E [biuro@trevibenne.pl](mailto:biuro@trevibenne.pl)  
[www.trevibenne.pl](http://www.trevibenne.pl)



 **WE ARE DEMOLITION**  
**TREVI BENNE™**



## seria **MK**

**PL** - Multiprocessory serii MK to wszechstronne, wielofunkcyjne narzędzia do pracy w każdych warunkach, a to wszystko dzięki wykorzystaniu uniwersalnego korpusu urządzenia oraz możliwości zastosowania wymiennych szczęk do różnych prac. Hydrauliczna wymiana jest całkowicie bezpieczna i pozwala operatorowi na znaczne skrócenie czasu potrzebnego do wymiany szczęk roboczych (nie ma już potrzeby ręcznego usuwania sworzni), co w konsekwencji ogranicza czas przestoju na budowie. Multiprocessory serii MK są idealnymi urządzeniami do wszelkich prac rozbiórkowych, recyklingu i odzysku materiałów oraz rekultywacji środowiska.

**ENG** - The MK SERIES MULTI KIT PROCESSOR is a multi-function tool for all working conditions by using a universal body attaching a variety of interchangeable demolition kits with a innovative system: no longer manual exchange, but with fast hydraulic one, without removing any structural pins. The Multi Kit Processor is the perfect equipment for any demolition, recycling, environmental reclamation and recovery jobs recommended to the professional user.



### UŻYTECZNOŚĆ



Dostępne w 7 różnych konfiguracjach  
Available in 7 replaceable kits

### BEZPIECZEŃSTWO



Łatwa wymiana szczęk roboczych  
Système accrochage / décrochage facile et sûr

### HYDR. WYMIANA SZCZĘK



Wymiana szczęk roboczych w mniej niż 3 minuty  
Less than 3 minutes to replace kits

### ŁATWOŚĆ OBSŁUGI



Operator może z łatwością wymienić szczęki bezpośrednio w miejscu pracy  
One single operator can easily replace the kit directly on site

### MOC



Siła krusząca o 25% większa od standardowych szczęk  
Crushing power increased by 25% from standard crusher

### SZYBKOŚĆ



Cykl pracy szybszy o 15% dzięki zastosowaniu zaworu "speed valve"  
Processing cycle is 15% faster thanks to a speed valve



# MULTI KIT SERIE MK



Zawór do blokowania i odblokowania szczęk  
Actuator valve to lock and unlock the kit

Wzmocniony silnik obrotu  
Reinforced rotation motor

Wymiana szczęk w mniej niż 3minuty  
Less than 3 minutes to replace kits

**SZYBKA  
WYMIANA**

Dostępne szczęki do łamania szun kolejowych  
Available with the new rail cropper Kit



Ręczna regulacja szybkości obrotu  
Manual regulation of the rotation speed

Zawór przyspieszający cykle pracy  
Speed multiplier valve

Łatwo wymienne noże i zęby  
Interchangeable blades and teeth

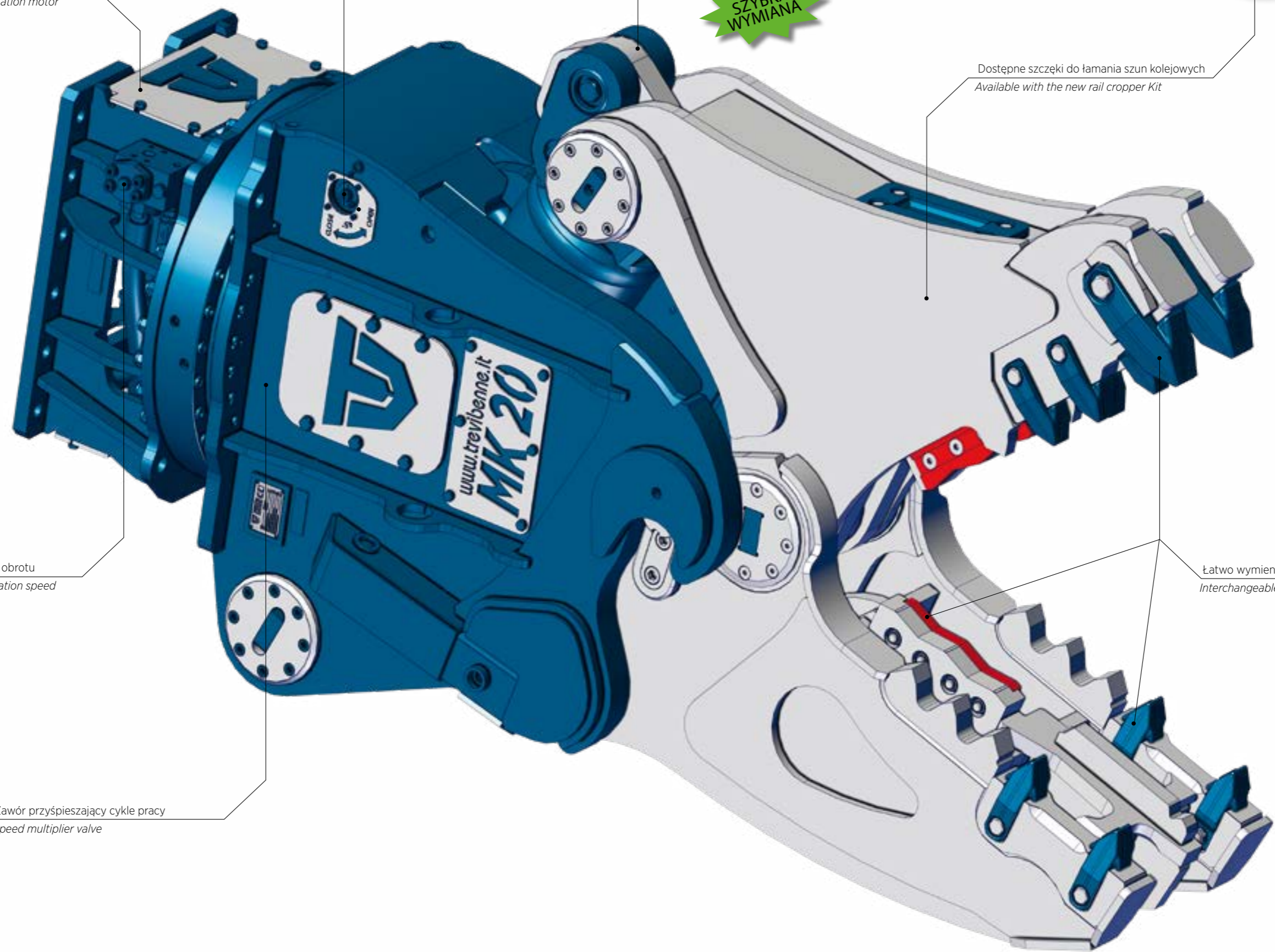

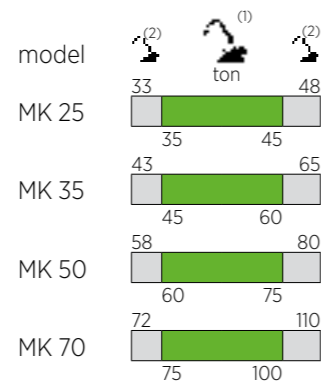
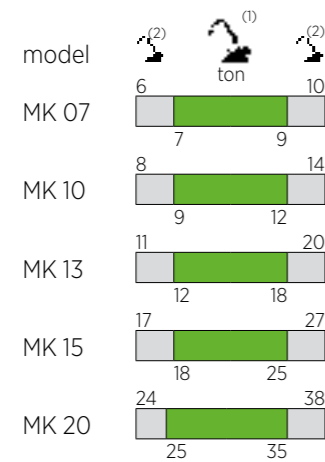

(1) Optymalna kombinacja koparka - osprzęt  
Optimum excavator-equipment combination

(2) Możliwa kombinacja koparka - osprzęt  
Possible excavator-equipment combination

		MK 07 *	MK 10 *	MK 13 *	MK 15	MK 20	MK 25	MK 35	MK 50	MK 70
	kg.	410	600	795	1180	1465	1970	2150	3420	5020
	mm.	810	1000	1055	1220	1330	1370	1375	1540	1720
	bar	280	310	310	310	310	310	310	340	340
	l/min.	80 / 150	150 / 250	180 / 250	180 / 250	200 / 300	250 / 350	300 / 400	400 / 500	450 / 600
	bar	140	140	140	140	140	140	140	140	140
	l/min.	10	10	10	10	10	10	10	30	30
		/	/	/	/	/	/	/	√	√

\*Wersja mechaniczna / \*\*Mechanical version  
\*\*H = H1 + H2

## Kit FR

Zestaw do rozdrabniania elementów betonowych - redukcja wielkości (przygotowanie materiału do kruszarki) i separacji stali zbrojeniowej.

Pulverizer Kit used to reduce concrete elements and, at the same time, separate the reinforcing round bar from it.

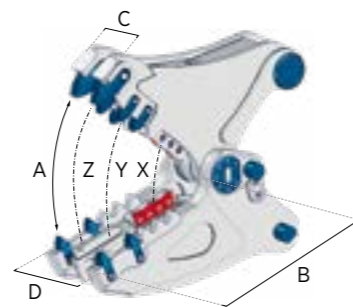

		Kit FR									
		MK 07	MK 10	MK 13	MK 15	MK 20	MK 25	MK 35	MK 50	MK 70	
	kg.	250	410	635	680	1035	1270	1720	2940	3940	
A	mm.	530	660	720	740	880	905	970	1100	1300	
B	mm.	510	610	630	660	790	820	860	1030	1130	
C	mm.	175	195	235	300	310	360	390	440	500	
D	mm.	305	355	390	465	485	570	640	720	770	
	mm.	140	140	180	220	260	260	260	260	325	
H2**	mm.	660	760	870	890	1045	1100	1210	1440	1580	
X	t.	75	110	125	190	205	290	330	400	535	
Y	t.	40	60	65	100	125	135	150	220	285	
Z	t.	30	40	50	65	80	105	115	140	190	
∅ max	mm.	20	25	30	35	40	45	50	60	75	
	mm.	/	/	/	/	/	/	/	/	/	
	mm.	/	/	/	/	/	/	/	/	/	
	mm.	/	/	/	/	/	/	/	/	/	

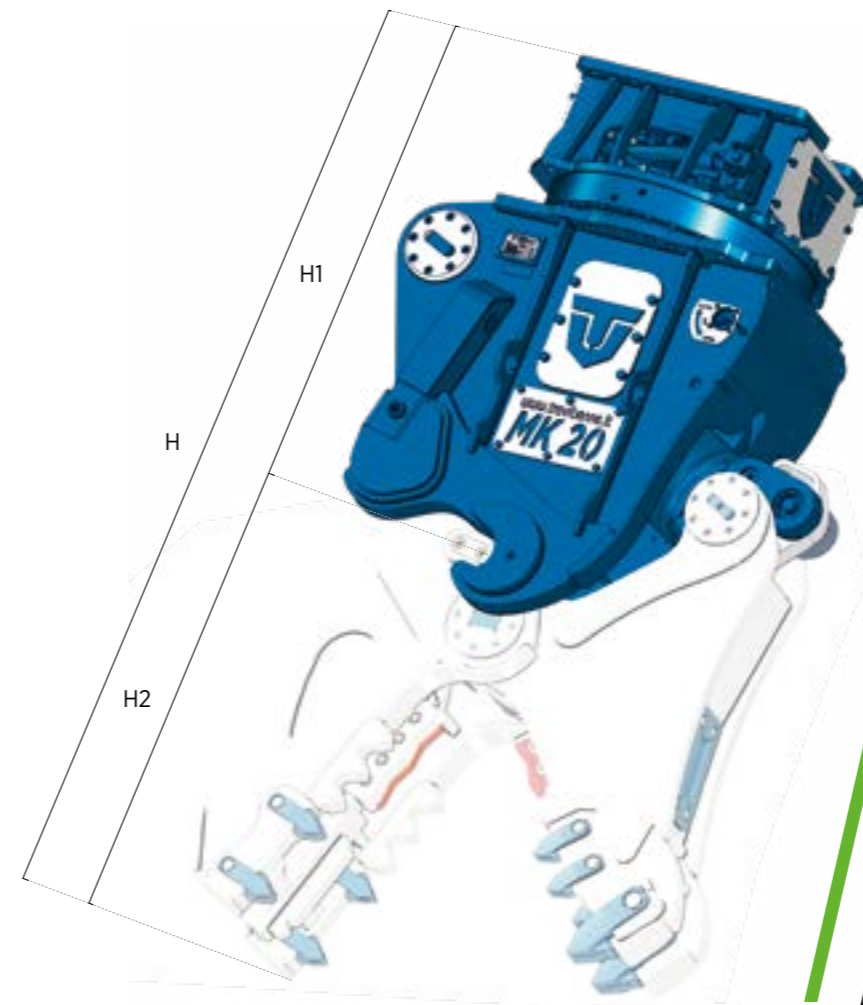

## Kit CS

Zestaw do rozbierek stalowych konstrukcji i recyklingu stali (cięcie różnego rodzaju materiałów stalowych tj. profile, płyty, rury itp.).

Shear Kit indicated for job sites and industrial demolition deposits and for cutting ferrous materials such as profiles, plate and pipes.



		Kit CS									
		MK 07	MK 10	MK 13	MK 15	MK 20	MK 25	MK 35	MK 50	MK 70	
	kg.	210	360	580	630	950	1240	1425	2290	2850	
A	mm.	250	320	400	420	480	500	525	575	700	
B	mm.	325	390	450	485	525	560	565	660	755	
C	mm.	65	75	80	100	120	130	130	135	165	
D	mm.	250	300	300	330	380	435	435	480	550	
	mm.	310	370	410	470	510	565	565	660	755	
H2**	mm.	545	630	725	775	890	935	990	1150	1300	
X	t.	175	250	310	420	515	720	740	875	1100	
Y	t.	70	100	120	155	235	290	315	385	470	
Z	t.	40	60	75	85	125	145	160	205	240	
∅ max	mm.	30	35	40	50	60	65	70	90	110	
	mm.	80	120	140	210	360	380	400	500	600	
	mm.	/	100	120	140	230	250	260	300	400	
	mm.	/	/	/	/	/	/	/	/	/	

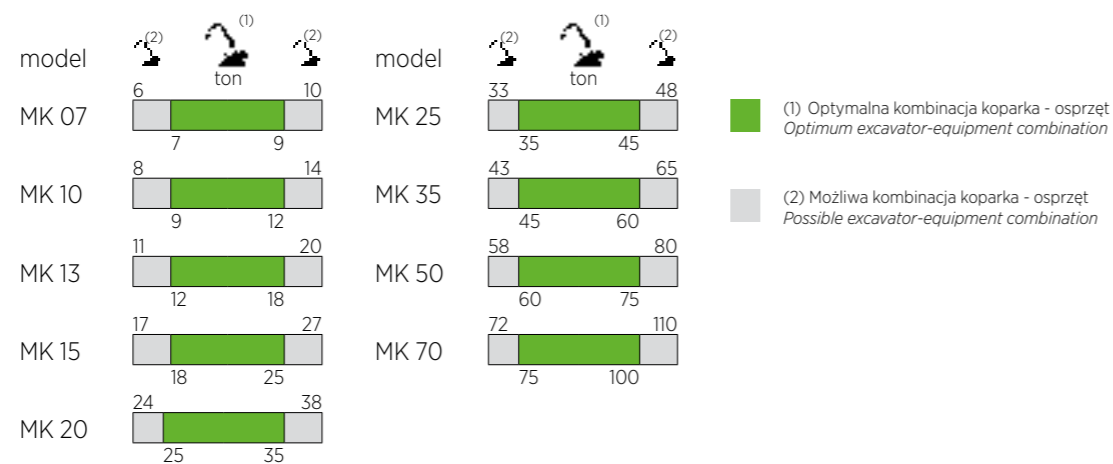

		MK 07 *	MK 10 *	MK 13 *	MK 15	MK 20	MK 25	MK 35	MK 50	MK 70
	kg.	410	600	795	1180	1465	1970	2150	3420	5020
H1**	mm.	810	1000	1055	1220	1330	1370	1375	1540	1720
	bar	280	310	310	310	310	310	310	340	340
	l/min.	80 / 150	150 / 250	180 / 250	180 / 250	200 / 300	250 / 350	300 / 400	400 / 500	450 / 600
	bar	140	140	140	140	140	140	140	140	140
	l/min.	10	10	10	10	10	10	10	30	30
		/	/	/	/	/	/	/	√	√

\*Wersja mechaniczna / \*\*Mechanical version  
 \*\*H = H1 + H2

## Kit CB

Zestaw do rozbiórki konstrukcji wykonanych z żelbetonu z dużą ilością stalowego zbrojenia.

Combi Kit for demolitions of structures made of reinforced concrete with a high percentage of ferrous materials.

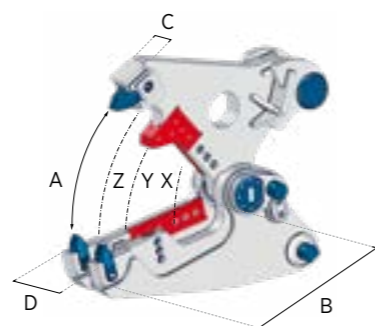

		Kit CB								
		MK 07	MK 10	MK 13	MK 15	MK 20	MK 25	MK 35	MK 50	MK 70
	kg.	*	450	585	720	1090	1305	1780	2900	3890
A	mm.	*	580	640	740	810	850	910	990	1160
B	mm.	*	560	700	720	800	815	875	1065	1180
C	mm.	*	100	100	110	130	130	130	175	185
D	mm.	*	290	310	320	350	410	410	560	610
	mm.	*	350	400	420	480	500	500	575	640
H2**	mm.	*	800	920	1000	1125	1155	1255	1490	1640
X	t.	*	220	270	420	510	700	740	900	1010
Y	t.	*	60	65	100	125	155	175	220	290
Z	t.	*	40	50	65	80	100	115	140	185
∅ max	mm.	*	30	35	40	45	50	55	70	85
	mm.	/	/	/	/	/	/	/	/	/
	mm.	/	/	/	/	/	/	/	/	/
	mm.	/	/	/	/	/	/	/	/	/

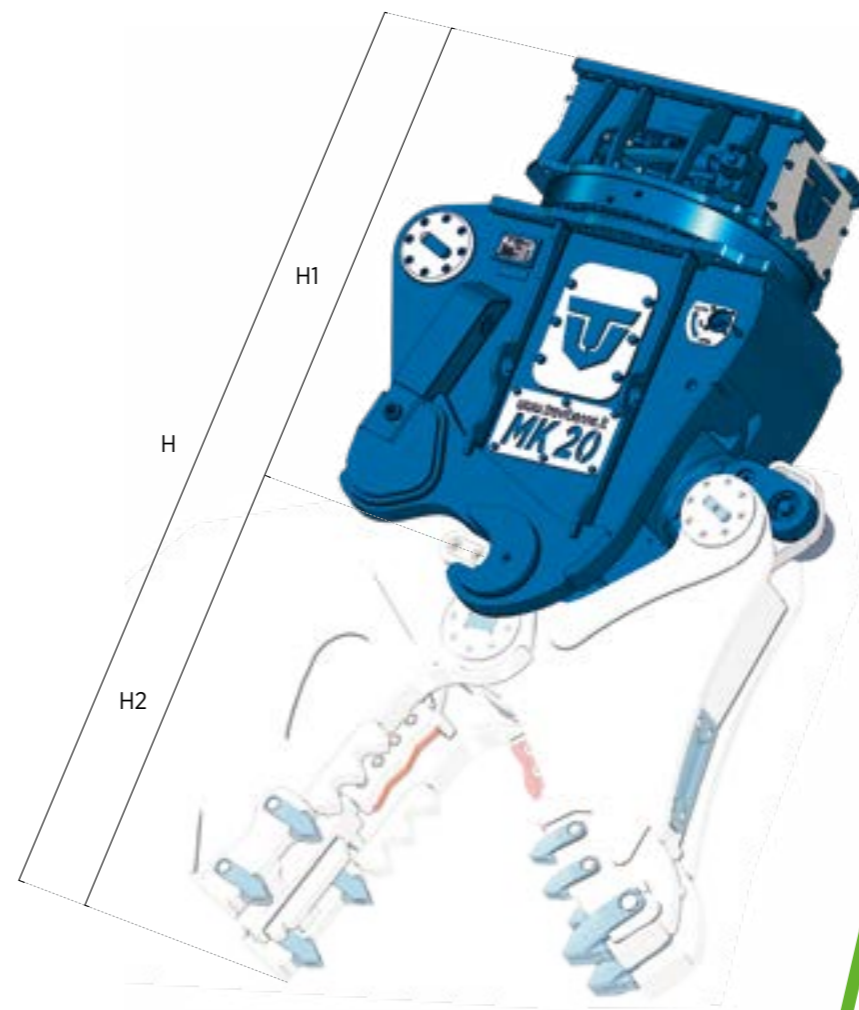

## Kit CH

Zestaw do efektywnej redukcji wielkości stalowego zbrojenia z kruszonego materiału.

Swiss Kit designed for immediate size reduction of steel rebar while crushing reinforced concrete.

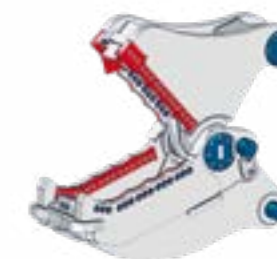

		Kit CH								
		MK 07	MK 10	MK 13	MK 15	MK 20	MK 25	MK 35	MK 50	MK 70
	kg.	*	*	610	740	1000	1300	1590	*	*
A	mm.	*	*	445	500	635	550	720	*	*
B	mm.	*	*	580	615	750	785	960	*	*
C	mm.	*	*	235	275	295	350	350	*	*
D	mm.	*	*	335	395	415	475	475	*	*
	mm.	*	*	530	530	660	600	750	*	*
H2**	mm.	*	*	900	910	1080	1100	1280	*	*
X	t.	*	*	245	260	375	720	740	*	*
Y	t.	*	*	105	115	150	215	220	*	*
Z	t.	*	*	60	80	100	130	135	*	*
∅ max	mm.	*	*	40	45	50	55	60	*	*
	mm.	/	/	/	/	/	/	/	/	/
	mm.	/	/	/	/	/	/	/	/	/
	mm.	/	/	/	/	/	/	/	/	/

\*Dostępny na zamówienie / \*Available on request

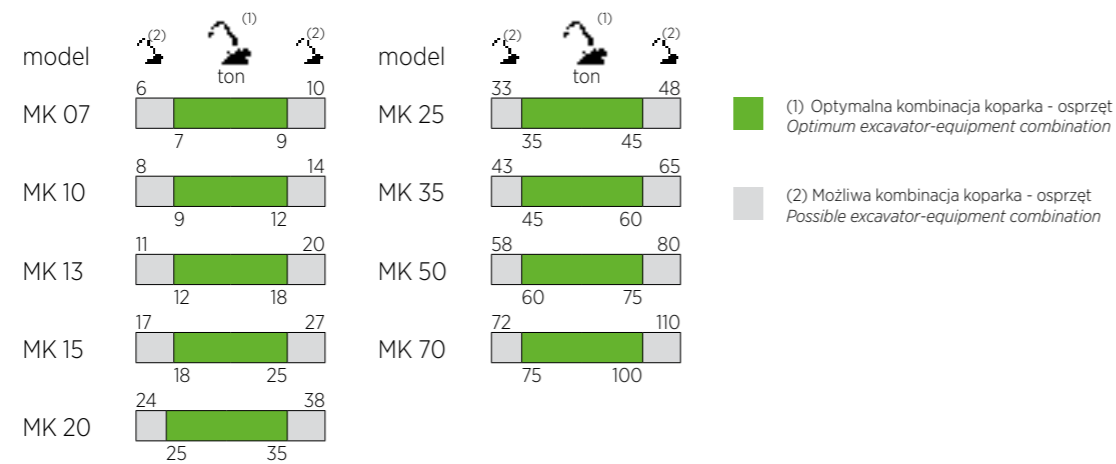

		MK 07 *	MK 10 *	MK 13 *	MK 15	MK 20	MK 25	MK 35	MK 50	MK 70
	kg.	410	600	795	1180	1465	1970	2150	3420	5020
H1**	mm.	810	1000	1055	1220	1330	1370	1375	1540	1720
	bar	280	310	310	310	310	310	310	340	340
	l/min.	80 / 150	150 / 250	180 / 250	180 / 250	200 / 300	250 / 350	300 / 400	400 / 500	450 / 600
	bar	140	140	140	140	140	140	140	140	140
	l/min.	10	10	10	10	10	10	10	30	30
		/	/	/	/	/	/	/	√	√

\*Wersja mechaniczna / \*\*Mechanical version  
\*\*H = H1 + H2

## Kit HC

Zestaw do wyburzeń I stopnia (cięcie żelbetonowych, zbrojonych stałą konstrukcji). Demontaż elementów na dużej wysokości. Precyzyjny, szybki i wydajny, zalecany do montażu na ramionach wyburzeniowych.

Crusher Kit for primary demolition with high precision, for the removal of structures and materials at relevant heights.

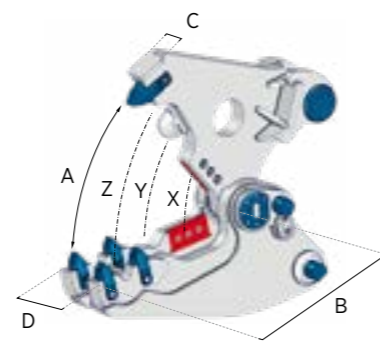

		Kit HC								
		MK 07	MK 10	MK 13	MK 15	MK 20	MK 25	MK 35	MK 50	MK 70
	kg.	250	435	575	680	1075	1235	1700	2750	*
A	mm.	535	600	680	745	870	880	925	1010	*
B	mm.	490	610	710	740	765	815	875	1070	*
C	mm.	90	100	100	110	130	130	130	175	*
D	mm.	240	300	300	340	350	400	450	550	*
	mm.	125	150	200	175	240	250	250	290	*
H2**	mm.	690	810	925	1005	1125	1170	1275	1500	*
X	t.	100	135	165	220	290	350	385	465	*
Y	t.	45	60	75	90	130	150	180	220	*
Z	t.	30	40	50	65	85	105	115	140	*
∅ max	mm.	20	25	30	35	40	45	50	60	*
	mm.	/	/	/	/	/	/	/	/	/
	mm.	/	/	/	/	/	/	/	/	/
	mm.	/	/	/	/	/	/	/	/	/

\*Dostępny na zamówienie / \*Available on request

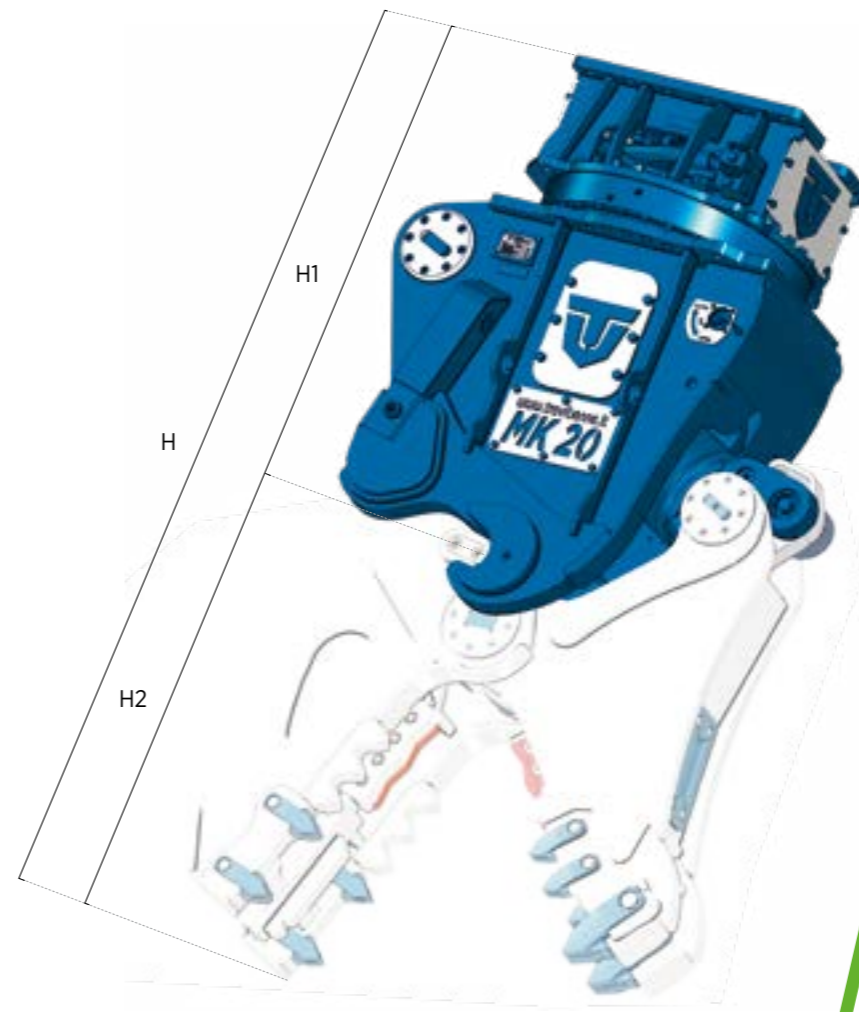

## Kit CL

Zestaw do cięcia stalowych zbiorników i silosów.

Tank-Plate Shear Kit with a specific profile to facilitate the continuous penetration for cutting tanks, silos and containers.



		Kit CL								
		MK 07	MK 10	MK 13	MK 15	MK 20	MK 25	MK 35	MK 50	MK 70
	kg.	*	*	*	560	1000	1400	1750	*	*
A	mm.	*	*	*	270	350	370	400	*	*
B	mm.	*	*	*	360	465	520	780	*	*
C	mm.	*	*	*	115	145	150	160	*	*
D	mm.	*	*	*	310	390	440	480	*	*
	mm.	*	*	*	320	400	430	480	*	*
H2**	mm.	*	*	*	505	630	695	750	*	*
X	t.	*	*	*	220	270	320	350	*	*
Y	t.	*	*	*	150	200	225	230	*	*
Z	t.	/	/	/	110	140	160	170	*	*
∅ max	mm.	/	/	/	/	/	/	/	/	/
	mm.	/	/	/	/	/	/	/	/	/
	mm.	/	/	/	/	/	/	/	/	/
	mm.	*	*	*	10	12	14	16	*	*

\*Dostępny na zamówienie / \*Available on request